

Amateur Radio Digital Standards

January 15, 2013 Version 1.0

April 18, 2013 Revision 1.01

YAESU MUSEN CO., LTD.

1 Revision History

Date	Version	Revisions
2013/01/15	1.0	First Issued
2013/04/18	1.01	Revision in Description

Contents

1	Revision History	2
2	Overview	6
3	Technical Conditions of Radio Equipment	7
3.1	Requirements.....	7
	(1) Radio Frequency Band.....	7
	(2) Modulation Scheme	7
	(3) Communication System.....	7
	(4) Antenna Power.....	7
	(5) Mode of Emission.....	7
	(6) Channel Spacing	7
	(7) Signal Transmission Rate.....	7
	(8) Frame Length	7
	(9) Voice Encoding Method.....	7
	(10) Concealment Function.....	7
3.2	Modulation Scheme Conditions	7
	(1) Modem System.....	7
	(2) Encoding.....	8
	(3) Transmission baseband bandwidth limit.....	8
	(4) Reception baseband bandwidth limit.....	8
3.3	Transmission Device Conditions.....	9
	(1) Frequency Tolerance.....	9
	(2) Occupied Frequency Bandwidth Tolerance.....	9
	(3) Permissible intensity of spurious emissions in the region outside the bandwidth	9
	(4) Permissible intensity of unwanted emissions in the spurious region.....	9
	(5) Antenna Power Tolerance	9
	(6) Enclosure Radiation.....	9
	(7) Transmission Rate Tolerance	9
	(8) Frequency Shift.....	9
	(9) Modulation Accuracy	9
3.4	Reception Equipment Conditions	9
	(1) Reference Sensitivity	9
	(2) Strength of Secondary Emitting Radio Waves.....	10
	(3) 15.109 Radiated Spurious Emissions.....	10
4	Communication Control Method	11
4.1	Communication System Overview	11

(1) Radio Channel Configuration.....	11
(2) Data Type.....	11
(3) Channel Type.....	11
4.2 V/D mode (simultaneous voice/data communication mode).....	13
4.2.1 V/D mode type 1 (simultaneous voice/data communication mode 1).....	13
(1) HC (Header CH) and TC (Terminator CH).....	13
(2) CC (Communication CH).....	14
(3) FS (Frame Sync)	14
(4) FICH (Frame Information CH)	14
(6) Breakdown of DCH (Data CH).....	17
(7) VCH (Voice CH) Breakdown.....	18
4.2.2 V/D mode type 2 (simultaneous voice/data communication mode 2)	19
(1) HC (Header CH) and TC (Terminator CH).....	19
(2) CC (Communication CH).....	19
(3) FS (Frame Sync)	20
(4) FICH (Frame Information CH)	20
(5) Breakdown of CSD (Callsign Data).....	20
(6) Breakdown of DCH (Data CH).....	20
(7) VCH (Voice CH) and VeCH (Voice Extend CH) Breakdown.....	21
4.2.3 Switching between Type 1 and Type 2 V/D mode (simultaneous voice /data communication mode).....	21
4.3 Data FR mode (high-speed data transmission mode).....	22
(1) HC (Header CH) and TC (Terminator CH).....	22
(2) CC (Communication CH).....	22
(3) FS (Frame Sync)	23
(4) FICH (Frame Information CH)	23
(5) Breakdown of CSD (Callsign Data).....	23
(6) Breakdown of DCH (Data CH).....	23
(7) Block management of DCH (Data CH)	24
4.4 Voice FR mode (High-quality voice full rate mode).....	26
(1) HC (Header CH) and TC (Terminator CH).....	26
(2) CC (Communication CH).....	26
(3) FS (Frame Sync)	27
(4) FICH (Frame Information CH)	27
(5) Breakdown of CSD (Callsign Data).....	27
(6) Breakdown of DCH (Data CH).....	27

(7) VCH (Voice CH) Breakdown.....	27
4.5 Details of the Error Check Bit	29
(1) FICH Section.....	29
(2) DCH Section.....	31
(3) VCH Section and VeCH Section.....	34
4.6 Communication Channel Start-up / Keep / Stop Conditions.....	35
(1) Communication Channel Start-up Procedure.....	35
(2) Communication Channel Keep Condition.....	35
(3) Communication Channel Stop Condition.....	35
4.7 Frame Synchronization	35
(1) Synchronization Establishment Conditions	35
(2) Out-of-Sync Conditions.....	35
Appendix.....	36
A. Extended Golay Code (24, 12, 8).....	36
B. Trellis encoder Coding rate $R = 1/2$ Constraint length $K = 5$	37

2 Overview

These standards and norms regulate the conditions regarding the use of digital communication systems as amateur radios. An overview of the system and the scope of application of these specifications are shown in **Figure 2-1**.

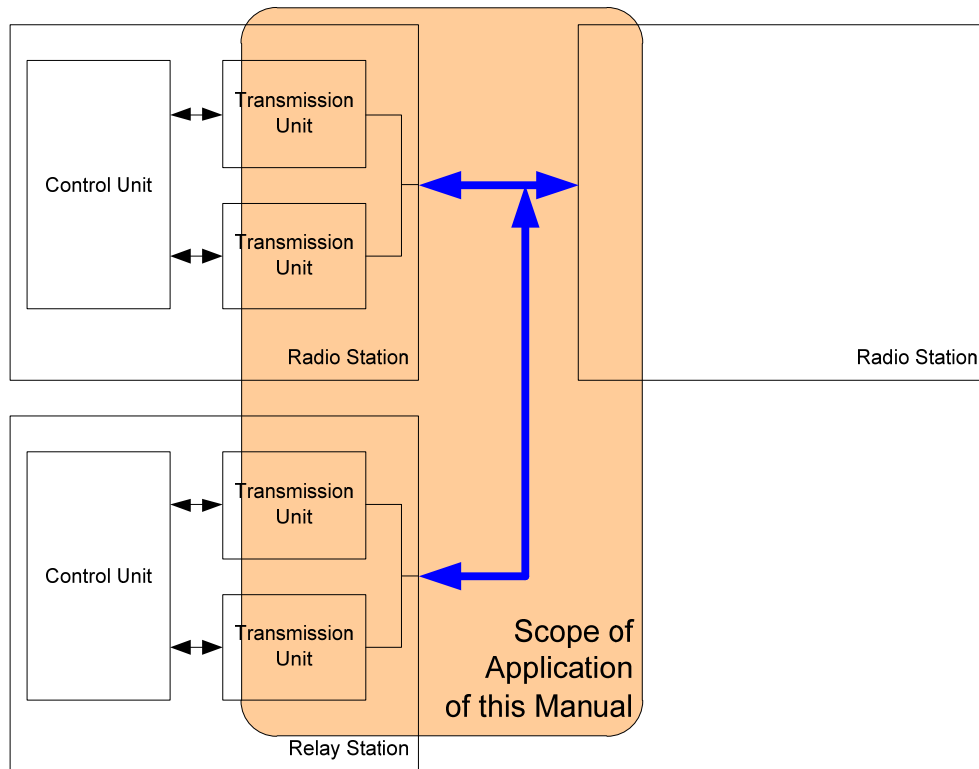

Figure 2-1 System Composition and Scope of Application of these Specifications

Direct communication between radio stations is carried out based on a half-duplex press-talk system. The communication system is either a simplex, half-duplex or broadcast system depending on the operation.

A relay station regenerates the bits of a carrier wave transmitted by a radio station and then sends out another carrier wave to another radio station.

Communication between radios is also carried out using the Continuous 4 Level Frequency Modulation (C4FM). Transmission rate is assumed to 9.6 kbps.

3 Technical Conditions of Radio Equipment

3.1 Requirements

(1) Radio Frequency Band

A frequency band assigned to amateur radios is used.

(2) Modulation Scheme

The modulation scheme used is the C4FM system.

(3) Communication System

The communication system used is either a simplex, half-duplex or broadcast system based on SCPC (Single Channel Per Carrier).

(4) Antenna Power

The antenna power must be less than the licensed value.

(5) Mode of Emission

The type of radio wave shall be F1D (data) or F7W (data and voice).

(6) Channel Spacing

The channel spacing shall be the channel spacing stipulated for amateur radios.

(7) Signal Transmission Rate

The signal transmission rate shall be 9.6 kbps.

(8) Frame Length

The frame length shall be 100 ms.

(9) Voice Encoding Method

The voice encoding rate shall be 7.2 kbps or less including error correction.

(10) Concealment Function

Concealment function is not provided.

3.2 Modulation Scheme Conditions

(1) Modem System

The modem system shall be the C4FM system.

The modulation procedure is shown in **Figure 3-1** while the demodulation procedure is shown in **Figure 3-2**.



Figure 3-1 C4FM modulation procedure

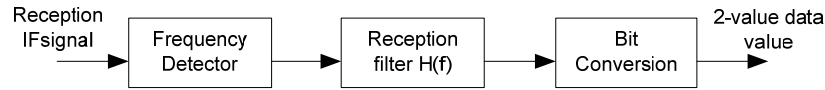

Figure 3-2 C4FM demodulation procedure

(2) Encoding

The binary data series of the serial input is entered into the modulation system after being converted into dibits starting from the leading bit of the signal format and then mapped onto the various symbols of the C4FM. The corresponding relationship between the dibit, symbol and frequency deviation is shown in **Table 3-1**.

Table 3-1 C4FM Mapping

Dibit	Symbol	Frequency Deviations
00	+1	+900 Hz
01	+3	+2700 Hz
10	-1	-900 Hz
11	-3	-2700 Hz

(3) Transmission baseband bandwidth limit

For 4-level symbols, the baseband bandwidth is limited by the transmission filter H(f) specified below.

$$|H(f)| = \int_0^1 \cos\left[\left(\frac{T}{4\alpha}\right)(2\pi|f| - \pi(1-\alpha)/T)\right]$$

$$0 \leq |f| < (1-\alpha)/2T$$

$$(1-\alpha)/2T \leq |f| < (1+\alpha)/2T$$

$$(1+\alpha)/2T \leq |f|$$

However, T (symbol spacing) must be equal to 1/4800 and α (roll-off ratio) must be equal to 0.2.

(4) Reception baseband bandwidth limit

For frequency-detected signals, the baseband bandwidth is limited by the transmission filter H (f) specified below.

$$|H(f)| = \int_0^1 \cos\left[\left(\frac{T}{4\alpha}\right)(2\pi|f| - \pi(1-\alpha)/T)\right]$$

$$0 \leq |f| < (1-\alpha)/2T$$

$$(1-\alpha)/2T \leq |f| < (1+\alpha)/2T$$

$$(1+\alpha)/2T \leq |f|$$

However, T (symbol spacing) must be equal to 1/4800 and α (roll-off ratio) must be equal to 0.2.

3.3 Transmission Device Conditions

(1) Frequency Tolerance

The frequency shall comply with the regulations for radio station equipment.

(2) Occupied Frequency Bandwidth Tolerance

The frequency shall comply with the regulations for radio station equipment.

(3) Permissible intensity of spurious emissions in the region outside the bandwidth

The frequency shall comply with the regulations for radio station equipment.

(4) Permissible intensity of unwanted emissions in the spurious region

The frequency shall comply with the regulations for radio station equipment.

(5) Antenna Power Tolerance

The frequency shall comply with the regulations for radio station equipment.

(6) Enclosure Radiation

Not specified.

(7) Transmission Rate Tolerance

Must be within +/-5 ppm.

(8) Frequency Shift

The frequency shift when entering a repeating (+3, +3, -3, -3, +3, +3, -3, -3) code sequence as a modulation signal must be at least 4050 Hz and not more than 4950 Hz.

(9) Modulation Accuracy

Must be 10% or less.

3.4 Reception Equipment Conditions

FCC Part15, Subpart B, ANSI C63.4-2003

(1) Reference Sensitivity

The bit error rate (BER) when bit transmitting a signal modulated by a binary pseudo noise

sequence with a bit period of code length 511 must be a value shown in **Table 3-2**.

Table 3-2 Reference Sensitivity

Condition	Static
BER	1×10^{-2}
Reference Level	0.0 dB μ V and below

(2) Strength of Secondary Emitting Radio Waves.

Not specified.

(3) 15.109 Radiated Spurious Emissions

Limits

Frequency [MHz]	[dBuV/m]@3m
30 - 88	40.0
80 - 216	43.5
216 - 960	46.0
Above 960	54.0

4 Communication Control Method

4.1 Communication System Overview

(1) Radio Channel Configuration

The radio channel configuration is shown in **Figure 4-1**.

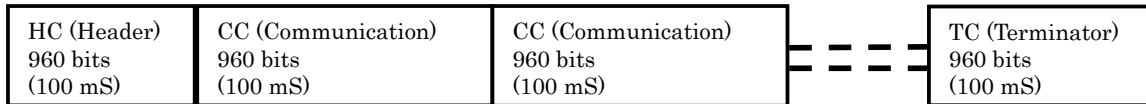

Figure 4-1 Radio Channel Configuration

During transmission, the Header Frame comes first, followed by the voice and data being sent via the CC Frame and finally the Terminator Frame comes last.

The various frames are all defined by 960 bit (100 msec@9600 bps).

The HC, CC and TC details will be provided later.

(2) Data Type

4 ways.

- (a) V/D mode type 1 (simultaneous voice/data communication mode 1)
- (b) V/D mode type 2 (simultaneous voice/data communication mode 2)
- (c) Data FR mode (high-speed data transmission mode)
- (d) Voice FR mode (high-quality voice full rate mode)

(3) Channel Type

The following four routes (**Figure 4-2**, **Figure 4-3**, **Figure 4-4** and **Figure 4-5**) are assumed.

(a) Direct Wave (Direct) Communications (**Figure 4-2**)

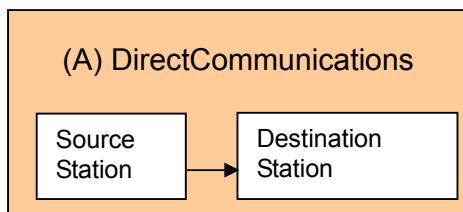

(b) Communications via Repeater (**Figure 4-3**)

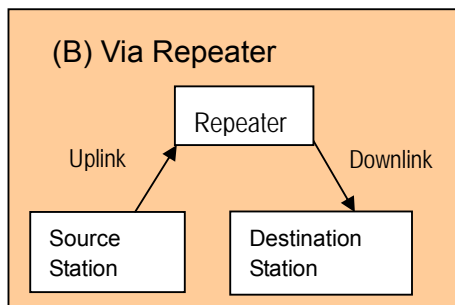

(c) Communication 1 via VoIP System (Figure 4-4)

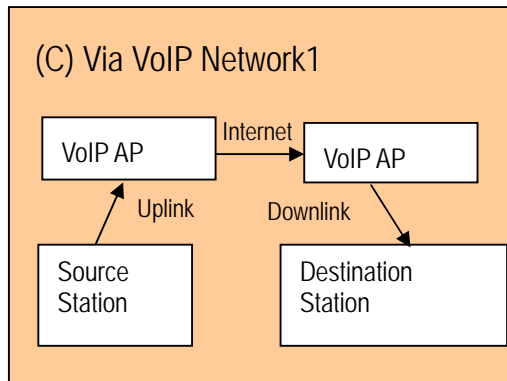

(d) Communication 2 via VoIP System (Figure 4-5)

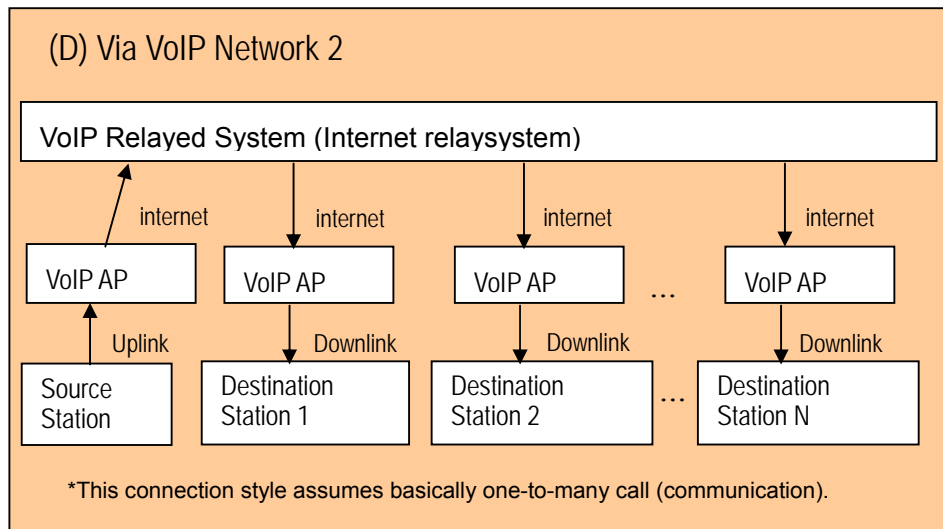

*The Source station is the signal transmission station while the Destination station is the signal reception station.

*VoIP AP is assumed to be a VoIP system base station (Access Point station).

*VoIP Relayed System is assumed to be a voice relay system existing in the Internet network.

*These channel types are determined from the MR value and VoIP value etc. in the FICH information (to be described later).

*In all cases from (a) to (d), communication reception by a third party is not precluded (receivable).

4.2 V/D mode (simultaneous voice/data communication mode)

4.2.1 V/D mode type 1 (simultaneous voice/data communication mode 1)

The frame composition is shown in **Figure 4-6**.

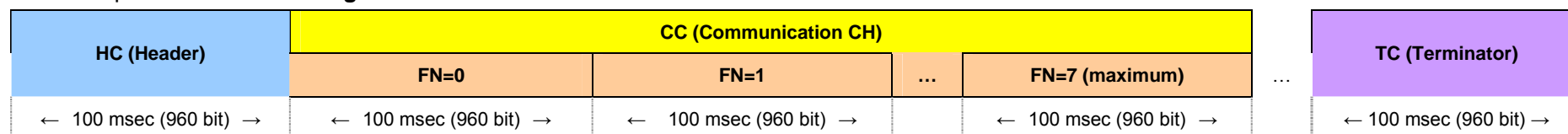

Figure 4-6 Frame Composition Drawing

*Voice and superimposed data etc. is entered into the above-mentioned CC section and during transmission, this part is transmitted repeatedly.

*The repeating pattern of the CC section above changes depending on the volume of the transmission data you wish to send.

(1) HC (Header CH) and TC (Terminator CH)

The Header and Terminator basically have the same structure. The structural diagram is shown in **Figure 4-7**. (HC/TC is differentiated by the F1 value in FICH.)

FS	FICH	DCH-1(0)	DCH-2(0)	DCH-1(1)	DCH-2(1)	DCH-1(2)	DCH-2(2)	DCH-1(3)	DCH-2(3)	DCH-1(4)	DCH-2(4)	Number of bits Total 960 bit
40	200	72	72	72	72	72	72	72	72	72	72	

Figure 4-7 HC & TC Structural Drawing

Bit Breakdown within the Frame

FS	Frame sync.	Synchronized symbol. (Refer to Section (3) for the details)
FICH	Frame Information CH	Frame information channel. (Refer to Section (4) for the details)
DCH-1	Data CH-1	The CSD1 (Callsign Data 1) which is divided into five parts (72 bit * 5 = 360 bit) is entered into DCH-1 of the Header. (Refer to Section (5) for the details of CSD1) $DCH-1 = DCH-1(0) + DCH-1(1) + DCH-1(2) + DCH-1(3) + DCH-1(4)$
DCH-2	Data CH-2	The CSD2 (Callsign Data 2) which is divided into five parts (72 bit * 5 = 360 bit) is entered into DCH-2 of the Header. (Refer to Section (5) for the details of CSD2) $DCH-2 = DCH-2(0) + DCH-2(1) + DCH-2(2) + DCH-2(3) + DCH-2(4)$

*CSD: Callsign Data (call sign information)

*Fill up using 0×20 (Space) when there is no information in CSD2. (during direct transmission)

(2) CC (Communication CH)

The structural diagram of the superimposed data and actual voice is shown in **Figure 4-8**.

FS	FICH	DCH (0)	VCH (0)	DCH (1)	VCH (1)	DCH (2)	VCH (2)	DCH (3)	VCH (3)	DCH (4)	VCH (4)	Number of bits Total 960 bit
40	200	72	72	72	72	72	72	72	72	72	72	

Figure -8 CC Structural Drawing

Bit Breakdown within the Frame

FS	Frame sync.	Synchronized symbol. (Refer to Section (3) for the details)
FICH	Frame Information CH	Frame information channel. (Refer to Section (4) for the details)
DCH	Data CH	CSD (Callsign Data) and text data to be superimposed and transmitted etc. is entered into DCH. (Total 360 bit) (Refer to Sections (5) and (6) for details)
VCH	Voice CH	The Vocoder voice is entered into VCH. (Voice information totaling 100 msec is entered in 20 msec blocks for every 72 bits.) (Details are shown in Section (7))

This section is transmitted repeatedly during voice transmission. (Refer to Section (6) for the repeating pattern)

(3) FS (Frame Sync)

Synchronized signal (40 bit) D471C9634D

(4) FICH (Frame Information CH)

The FICH section is composed using 200 bit and includes actual data (32 bit) and check bit (168 bit). (Refer to Section 4.5 (1) for details on the check bit)

The structural drawing of the actual FICH data is shown in **Figure 4-9**.

31	30	29	28	27	26	25	24	23	22	21	20	19	18	17	16	15	14	13	12	11	10	9	8	7	6	5	4	3	2	1	0
FI	CS	CM	BN	BT	FN	FT	reserved	MR	VoIP	DT	SQL	SC (Squelch code)																			

Figure 4-9 FICH Actual Data Structure

The field composition of the actual FICH data is shown in **Table 4-1**.

Table 4-1 Field Composition of Actual FICH Data

Field Name	Byte Length	Definition of Field
Frame Type (FI: Frame Information)	2	Shows the radio channel type of the frame. 00: Header Channel (HC) 01: Communication Channel (CC) 10: Terminator Channel (TC) 11: Test Channel
Type of Callsign (CS: Callsign Information)	2	Shows the callsign in the frame. 00: Reserve 01: Reserve 10: Assign callsigns 1, 2 and 3 11: Reserve
Type of Call (CM: Call Mode)	2	Shows an individual mode or Group/CQ mode. 00: Group/CQ mode 01: Reserve 10: Reserve 11: Individual mode
Block Number (BN: Block Number)	2	Shows the block number when dividing and sending data.
Block Total (BT: Block Total)	2	Shows the block total when dividing and sending data
Frame number (FN: Frame Number)	3	Shows the frame number when dividing and sending data.
Frame Total (FT: Frame Total)	3	Shows the frame total when dividing and sending data.
Message Path (MR: Message Routing)	3	Shows the transmission path of the message. 000: Direct wave communication 001: Downlink (uplink not busy) 010: Downlink (uplink busy) 011: Reserve : 111: Reserve
VoIP Path (VoIP)	1	Shows the VoIP communication path. 0: Local (simplex) 1: via Internet (repeated)
Data Type (DT: Data Type)	2	Shows the frame data type. 00: V/D mode type 1 (simultaneous voice/data communication mode 1) 01: Data FR mode (high-speed data transmission mode) 10: V/D mode type 2 (simultaneous voice/data communication mode 2) 11: Voice FR mode (high-quality voice full rate mode)
SQL Type (SQL type)	1	0: SQL code enabled 1: SQL code disabled
SQL Code (SC: Squelch Code)	7	0000000: No value 0000001: SQL Code (1) . . . 1111110: SQL Code (126) 1111111: Break Out code

In the V/D mode type 1 (simultaneous voice/data communication mode 1), the DT value (Data Type) is specified as 00.

(5) Breakdown of CSD (Callsign Data)

The Callsign Data is an area where the call sign information of an amateur radio station is entered. The information is shown in **Table 4-2**.

Table 4-2 Call sign information of an amateur radio station

Callsign Data		bit	Call Sign Information		Information Content
CSD1	Dest	80	Destination Callsign	Address Callsign	Specify the Destination Callsign /Group Name etc.
	Src	80	Source Callsign	Transmission Source Callsign	Specify the transmission source callsign.
CSD2	Downlink	80	DownLink Callsign	DownLink Station Callsign	The DownLink station callsign of the repeater station or VoIP station is entered.
	Uplink	80	UpLink Callsign	Callsign of UpLink Station	The UpLink station callsign of the repeater station or VoIP station is entered.
CSD3	Rem1	40	Remark text 1	Callsign Supplementary Information 1	The DownLink ID information of the repeater station or VoIP station is entered.
	Rem2	40	Remarks text 2	Callsign Supplementary Information 2	The UpLink ID information of the repeater station or VoIP station is entered.
	Rem3	40	Remarks text 3	Callsign Supplementary Information 3	The ID number of the VoIP station (relay system ID on the Internet) is entered.
	Rem4	40	Remarks text 4	Callsign Supplementary Information 4	Specify the radio ID of the transmission source station.

The Callsign of the CSD1/CSD2 section is composed respectively of actual data in 10 byte (80 bit).

The Rem1 - Rem4 ID numbers of CSD3 are respectively composed in 5 byte (40 bit).

Callsign Data is handled in the Header, Terminator and DCH (Data CH) to be described later.

Radio ID: Device-specific identification number (5 byte).

When the repeater station sends (relays) the signal coming from the Uplink CH of your own station to the Downlink CH as it is, the Rem 1/2 information contains the Radio ID of your own station (repeater station).

When transmitting signals relayed via the Internet using the Downlink, the VoIP station ID information is also included.

The Callsign information to be sent by DCH (Data CH) is as follows.

CS=10 (bin) CSD1 + CSD2 + CSD3 (Dest/Src/Down/Up/Rem1/2/3/4)

*By handling CSD information using the CC (Communication CH), the signal address can be located even if the signal is received midway.

(6) Breakdown of DCH (Data CH)

The DCH section is composed using 360 bit and includes actual data (160 bit) and check bit (200 bit). (Refer to Section 4.5 (2) for details on the check bit)

In the V/D mode (simultaneous voice/data communication mode), the information of the CC (Communication CH) is transmitted repeatedly during voice transmission using the PTT.

This repeating pattern changes as follows according to the DT (Data) volume that you wish to send.

The changes are shown in **Table 4-3**.

*The DT section can handle actual data totaling 800 bit (100 byte) for DT1 - DT5.

- FT Frame Total The frame is transmitted repeatedly once every FT value.
- FN Frame Number The FN value is a serial number applied to the repeating Frame.
- CS Callsign Information CS=10 (bin) fixed

(All values are defined in FICH.)

Table 4-3 V/D mode type 1 case

FT	FN=0	FN=1	FN=2	FN=3	FN=4	FN=5	FN=6	FN=7	Transmission data length (DT)	
2	CSD1	CSD2	CSD3						When there is not data	Rolling for every three frames
3	CSD1	CSD2	CSD3	DT1					When DT=1-20 byte	Rolling for every four frames
4	CSD1	CSD2	CSD3	DT1	DT2				When DT=21-40 bytes	Rolling for every five frames
5	CSD1	CSD2	CSD3	DT1	DT2	DT3			When DT=41-60 bytes	Rolling for every six frames
6	CSD1	CSD2	CSD3	DT1	DT2	DT3	DT4		When DT=61-80 bytes	Rolling for every seven frames
7	CSD1	CSD2	CSD3	DT1	DT2	DT3	DT4	DT5	When DT=81-100 bytes	Rolling for every eight frames

(7) VCH (Voice CH) Breakdown

The transmission rate of the voice signal must be 3.6 kbps or less including the error correction code. Voice encoding follows the standards stipulated for a frame size of 20 ms (72 bit), voice code of 2.45 kbps, error correction code of 1.15 kbps Digital Voice Systems, Inc's AMBE+2™ Enhanced Half-Rate (3600 bps).

49 bit voice encoded data and 23 bit error correction data is generated for each frame (20 ms) and bit assignment to the VCH is composed of five frames of (100 ms: 360 bit) voice encoded data. VCH bit allocation is as shown in **Figure 4-10**.

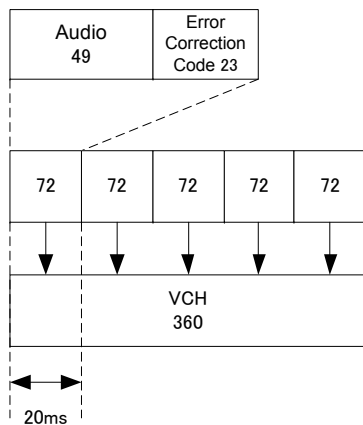

Figure 4-10 VCH Bit Allocation

4.2.2 V/D mode type 2 (simultaneous voice/data communication mode 2)

The frame composition is shown in **Figure 4-11**.

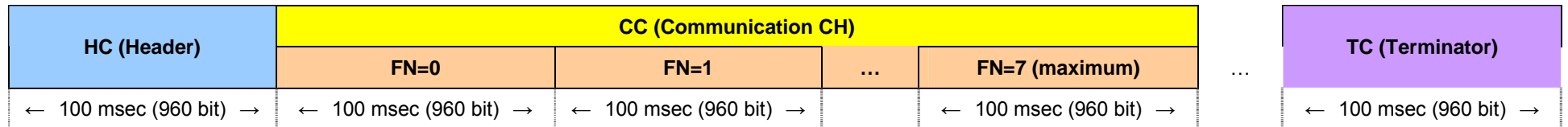

Figure 4-11 Frame Composition Drawing

*Voice and simultaneously superimposed data etc. is entered into the above-mentioned CC section and during transmission, this part is transmitted repeatedly.

*The repeating pattern of the CC section above changes depending on the volume of the transmission data you wish to send.

(1) HC (Header CH) and TC (Terminator CH)

The Header and Terminator are exactly the same as in the case for V/D mode type 1 (refer to Section **4.2.1 (1)**).

(2) CC (Communication CH)

The structural diagram of the superimposed data and actual voice is shown in **Figure 4-12**.

FS	FICH	DCH (0)	VCH (0)	VeCH (0)	DCH (1)	VCH (1)	VeCH (1)	DCH (2)	VCH (2)	VeCH (2)	DCH (3)	VCH (3)	VeCH (3)	DCH (4)	VCH (4)	VeCH (4)	Number of bits
40	200	40	72	32	40	72	32	40	72	32	40	72	32	40	72	32	Total 960 bit

Figure 4-12 CC Structural Drawing

Bit Breakdown within the Frame

- FS Frame sync. Synchronized symbol. (Refer to Section **(3)** for the details)
- FICH Frame Information CH Frame Information Channel (Refer to Section **(4)** for the details)
- DCH Data CH CSD (Callsign Data) and text data to be superimposed and transmitted etc. is entered into DCH. (Total 200 bit) (refer to Sections **(5)** and **(6)**)
- VCH Voice CH Error corrected voice is entered in VCH. (72/104 bit voice data) (refer to Section **4.5 (3)**)
- VeCH Voice Extend CH Error corrected voice is entered in VeCH. (32/104 bit voice data) (refer to Section **4.5 (3)**)

This section is transmitted repeatedly during voice transmission. (Refer to Section **(6)** for the repeating pattern)

(3) FS (Frame Sync)

Same as Section 4.2.1 (3).

(4) FICH (Frame Information CH)

Same as Section 4.2.1 (4).

In V/D mode type 2, the DT value (Data Type) is specified as 10.

(5) Breakdown of CSD (Callsign Data)

Same as Section 4.2.1 (5).

*In V/D mode type 2, the data needs to be divided and sent in 20-byte packages as shown in Section (6).

(6) Breakdown of DCH (Data CH)

The DCH section is composed using 200 bit and includes actual data (80 bit) and check bit (120 bit). (Bit configuration that is less than V/D mode type 1) (refer to Section 4.5 (2) for the check bit)

Similar to V/D mode type 1 (simultaneous voice/data communication mode 1), the information of the CC (Communication CH) is transmitted repeatedly during voice transmission using the PTT.

This repeating pattern changes as follows according to the DT (Data) volume that you wish to send.

The changes are shown in **Table 4-4**.

*The DT section can handle actual data totaling 160 bit (20 byte) for DT1 - DT2.

FT	Frame Total	The frame is transmitted repeatedly once every FT value.
FN	Frame Number	The FN value is a serial number applied to the repeating Frame.
CS	Callsign Information	CS=10 (bin) fixed

(All values are defined in FICH.)

Table 4-4 V/D mode type 2 case

FT	FN=0	FN=1	FN=2	FN=3	FN=4	FN=5	FN=6	FN=7	Transmission data length (DT)	
5	Dest	Src	Down	Up	Rem1+2	Rem3+4			When there is not data	Rolling for every six frames
6	Dest	Src	Down	Up	Rem1+2	Rem3+4	DT1		When DT=1-10 byte	Rolling for every seven frames
7	Dest	Src	Down	Up	Rem1+2	Rem3+4	DT1	DT2	When DT=11-20 byte	Rolling for every eight frames

(7) VCH (Voice CH) and VeCH (Voice Extend CH) Breakdown

Refer to Section 4.5 (3).

4.2.3 Switching between Type 1 and Type 2 V/D mode (simultaneous voice /data communication mode)

When text data needs to be added as transmission information during communication, switch between Type 1 and Type 2 modes depending on the data volume.

The frame composition is shown in **Figure 4-13**.

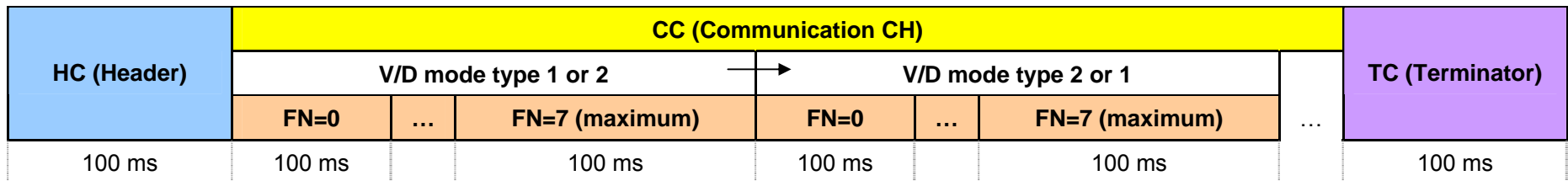

Figure 4-13 Frame Composition Drawing

*Rolling is carried out during transmission until there is a request to switch the Type (make sure rolling is carried out at least once).

4.3 Data FR mode (high-speed data transmission mode)

The frame composition is shown in **Figure 4-14**.

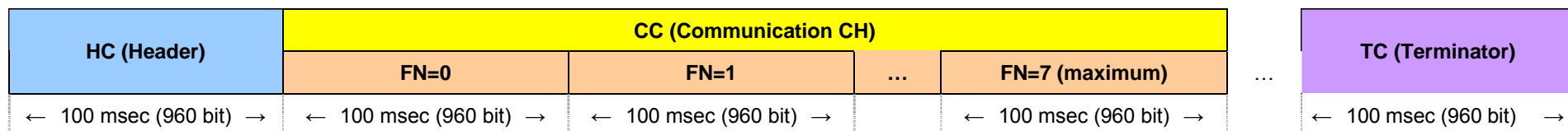

Figure 4-14 Frame Composition Drawing

*Data is entered into the above-mentioned CC section. For large data volumes, block transfer (Section (7)) is supported.

(1) HC (Header CH) and TC (Terminator CH)

The Header and Terminator are exactly the same as in the case for V/D mode (refer to Section 4.2.1 (1)).

(2) CC (Communication CH)

The data structural diagram is shown in **Figure 4-15**.

FS	FICH	DCH-1(0)	DCH-2(0)	DCH-1(1)	DCH-2(1)	DCH-1(2)	DCH-2(2)	DCH-1(3)	DCH-2(3)	DCH-1(4)	DCH-2(4)	Number of bits
40	200	72	72	72	72	72	72	72	72	72	72	Total 960 bit

Figure 4-15 CC Structural Drawing

Bit Breakdown within the Frame

FS	Frame sync.	Synchronized symbol. (Refer to Section (3) for details)
FICH	Frame Information CH	Frame Information Channel (Refer to Section (4) for details)
DCH-1	Data CH-1	CSD (Callsign Data) and text data to be superimposed and transmitted etc. are entered in DCH. (Total 360 bit) (Refer to Sections (5) and (6) for details)
DCH-2	Data CH-2	DCH-2 is also the same as DCH-1. (Total 360 bit) (Refer to Sections (5) and (6) for details)
		$DCH-1 = DCH-1(0) + DCH-1(1) + DCH-1(2) + DCH-1(3) + DCH-1(4)$
		$DCH-2 = DCH-2(0) + DCH-2(1) + DCH-2(2) + DCH-2(3) + DCH-2(4)$
		$DCH = DCH-1 + DCH-2$

In this mode, no same data is repeated and sent.

(3) FS (Frame Sync)

Same as Section **4.2.1 (3)**.

(4) FICH (Frame Information CH)

Same as Section **4.2.1 (4)**.

In the Data FR mode (data communication), the DT value (Data Type) is specified as 01.

(5) Breakdown of CSD (Callsign Data)

Same as Section **4.2.1 (5)**.

(6) Breakdown of DCH (Data CH)

The DCH section is composed using two 360 bit groups and includes actual data (160 bit) and check bit (200 bit) for each 360 bit. (Refer to Section **4.5 (2)** for details on the check bit)

*The DT section can handle actual data totaling 2080 bit (260 byte) for DT1 - DT13.

The same data will not be transmitted repeatedly in the Data FR mode.

The changes according to the DT (Data) volume you wish to send are shown in **Table 4-5**.

FT	Frame Total	The frame is transmitted repeatedly once every FT value.
FN	Frame Number	The FN value is a serial number applied to the repeating Frame.
CS	Callsign Information	CS=10 (bin) fixed

(All values are defined in FICH.)

Table 4-5 For Data FR mode

FT	FN=0		FN=1		FN=2		FN=3		FN=4		FN=5		FN=6		FN=7		Transmission data length (DT)	
1	CSD1	CSD2	CSD3	DT1														When DT=1-20 byte
2	CSD1	CSD2	CSD3	DT1	DT2	DT3											When DT=21-60 bytes	
3	CSD1	CSD2	CSD3	DT1	DT2	DT3	DT4	DT5									When DT=61-100 bytes	
4	CSD1	CSD2	CSD3	DT1	DT2	DT3	DT4	DT5	DT6	DT7							When DT=101-140 bytes	
5	CSD1	CSD2	CSD3	DT1	DT2	DT3	DT4	DT5	DT6	DT7	DT8	DT9					When DT=141-180 bytes	
6	CSD1	CSD2	CSD3	DT1	DT2	DT3	DT4	DT5	DT6	DT7	DT8	DT9	DT10	DT11			When DT=181-220 bytes	
7	CSD1	CSD2	CSD3	DT1	DT2	DT3	DT4	DT5	DT6	DT7	DT8	DT9	DT10	DT11	DT12	DT13	When DT=221-260 bytes	

(7) Block management of DCH (Data CH)

Continuous transmission of a maximum of four blocks is stipulated with the above mentioned CC (FN=0-7) taken as a single block.

The block structural diagrams are shown in **Figure 4-16**, **Figure 4-17**, **Figure 4-18** and **Figure 4-19**.

BT Block Total The number of blocks to be sent continuously.

BN Block Number A serial number assigned to each block.

(All values are defined in FICH.)

*A maximum of 260*4=8320 bit (1040 byte) of actual data for four blocks in total can be handled.

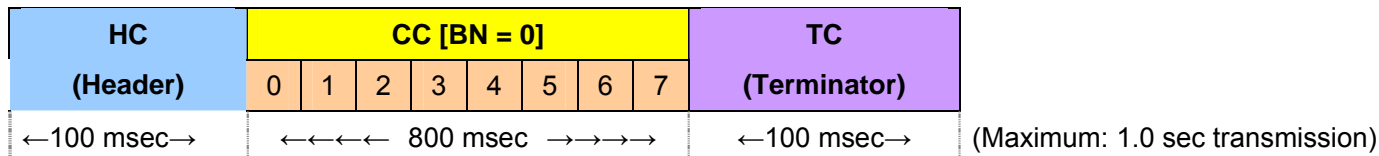

Figure 4-16 Block Structural Drawing (BT=0)

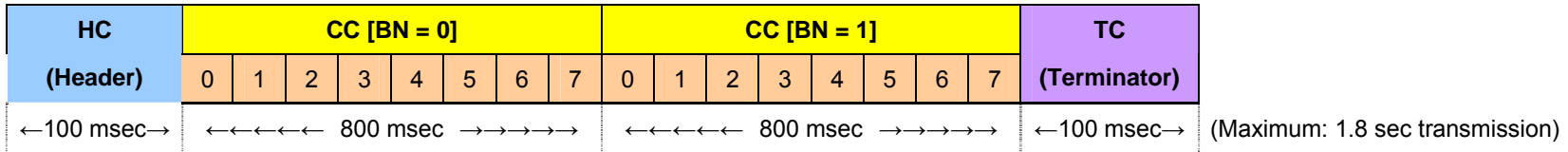

Figure 4-17 Block Structural Drawing (BT=1)

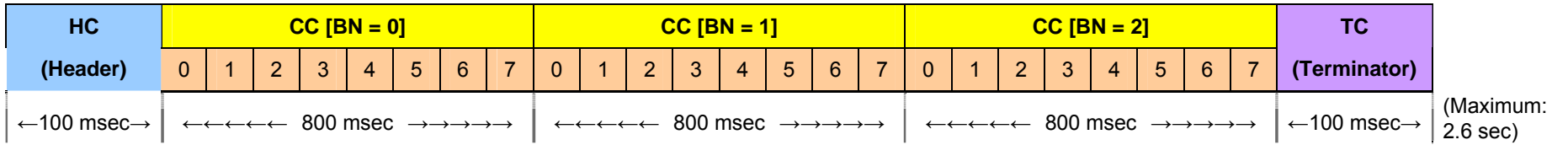

Figure 4-18 Block Structural Drawing (BT=2)

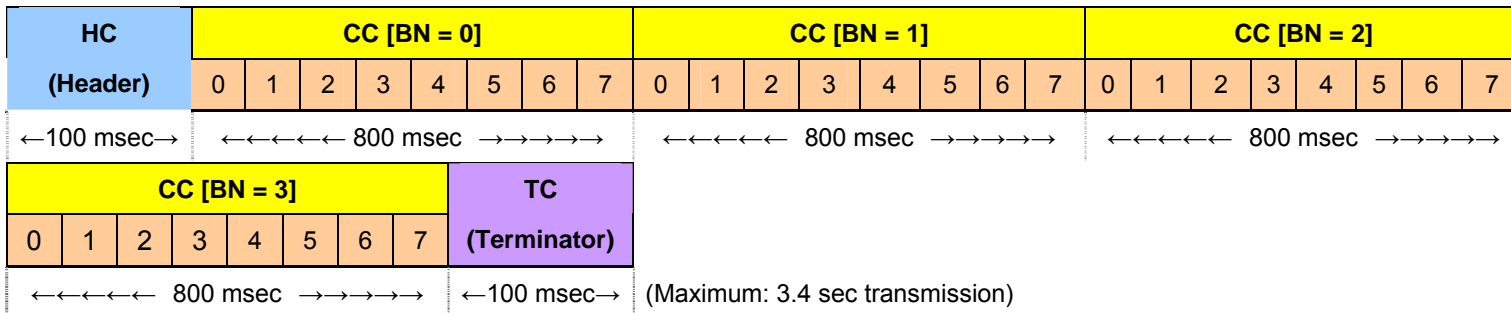

Figure 4-19 Block Structural Drawing (BT=3)

4.4 Voice FR mode (High-quality voice full rate mode)

The frame composition is shown in **Figure 4-20**.

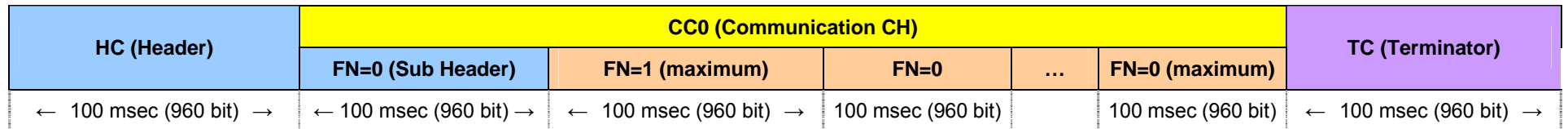

Figure 4-20 Frame Composition Drawing

*As **not all Call sign information can be sent using HC alone**, only the first frame just after the HC shall have a special structure.

Specifically, FT is assumed to be 1 just after the HC only and only the **FT=1/FN=0** frame (CC0) at that time shall have a special structure that includes CSD3.

Thereafter, all transmissions shall be at AMBE full rate.

Under this pattern, **when the initial HC and initial CC (Sub header (CSD3)) cannot be received, the Call sign information can not be obtained.**

No CSD3 information can be obtained from other frames except the **FT=1/FN=0** frame.

(1) HC (Header CH) and TC (Terminator CH)

The Header and Terminator are exactly the same as in the case of V/D mode (refer to Section **4.2.1 (1)**).

(2) CC (Communication CH)

The structural drawing of the CC0 (Sub Header CH) actual voice and superimposed data is shown in **Figure 4-21**.

FS	FICH	DCH (0)	DCH (1)	DCH (2)	DCH (3)	DCH (4)	Reserved	VCH (3)	VCH (4)	Number of bits
40	200	72	72	72	72	72	72	144	144	

Figure 4-21 CC0 Structural Drawing

The structural drawing of the CC actual voice is shown in **Figure 4-22**.

FS	FICH	VCH (0)	VCH (1)	VCH (2)	VCH (3)	VCH (4)	Number of bits
40	200	144	144	144	144	144	

Figure 4-22 CC Structural Drawing

Bit Breakdown within the Frame

FS	Frame sync.	Synchronized symbol. (Refer to Section (3) for details)
FICH	Frame Information CH	Frame Information Channel (Refer to Section (4) for details)
DCH	Data CH	Send all Callsign information by HC and CC0. (Refer to Sections (5) and (6) for details)
VCH	Voice CH	The Vocoder voice is entered into VCH. (All AMBE Full Rate) (refer to Section (7) for details)

(3) FS (Frame Sync)

Same as Section 4.2.1 (3).

(4) FICH (Frame Information CH)

Same as Section 4.2.1 (4).

(5) Breakdown of CSD (Callsign Data)

Send all Callsign information using the DCH of HC and CC0.

(6) Breakdown of DCH (Data CH)

Text cannot be transmitted.

(7) VCH (Voice CH) Breakdown

The transmission rate of the voice signal must be 7.2 kbps or less including the error correction code. Voice encoding follows the standards stipulated for a frame size of 20 ms (144 bit), voice code of 4.4 kbps, error correction code of 2.8 kbps Digital Voice Systems, Inc's AMBE+2™ Enhanced Full-Rate (7200 bps).

88 bit voice encoded data and 56 bit error correction data is generated for each frame (20 ms) and bit assignment to the VCH is composed of five frames of (100 ms: 720 bit) voice encoded data. VCH bit allocation is as shown in **Figure 4-23**.

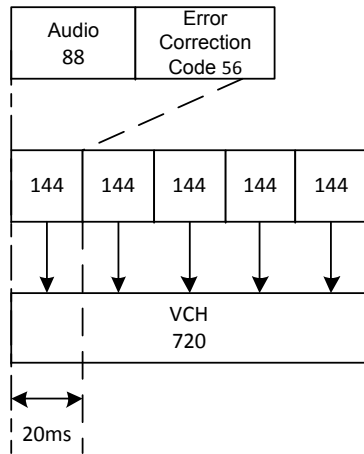

Figure 4-23 VCH Bit Allocation

4.5 Details of the Error Check Bit

(1) FICH Section

Frame Information Channel (FICH: Frame Information CH)

(a) Encoding Procedure

The FICH encoding procedure is shown in **Figure 4-24**.

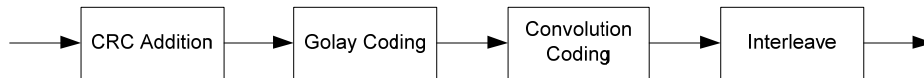

Figure 4-24 FICH Encoding Procedure

(b) Error Detection Code

16 bit CRC

Generator polynomial: $x^{16} + x^{12} + x^5 + 1$

The configuration of the CRC encoder must be as shown in **Figure 4-25**. The initial values of all the shift registers $S_{15} - S_0$ shall be zero and all bits must be inverted at the end.

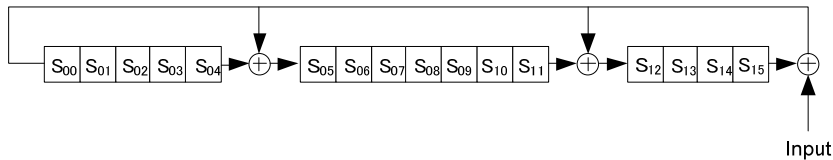

Figure 4-25 CRC16 Encoder Configuration

(c) Golay Coding (refer to **Appendix A**)

The input bit must be divided into 12 bit segments starting from the top and extended Golay coding (Golay (24, 12, 8)) must be carried out for each segment.

(c) Trellis Coding (refer to **Appendix B**)

The convoluted coding shown below must be carried out using a sequence with four fixed bits (All 0) added at the end of an input bit string as input. The output bit must be read alternately in the order of G_1 followed by G_2 .

Coding rate $R = 1/2$

Constraint length $K = 5$

Generator polynomial: $G_1 = x^4 + x^3 + 1$
 $G_2 = x^4 + x^2 + x + 1$

(e) Interleave

After reading the input bit in 2 bit segments and then after making a dibit, an interleave with block length $M = 5$ dibits and depth $N = 10$ must be carried out.

(f) Encoding Details

The encoding details of the frame information channel is shown in **Figure 4-26**.

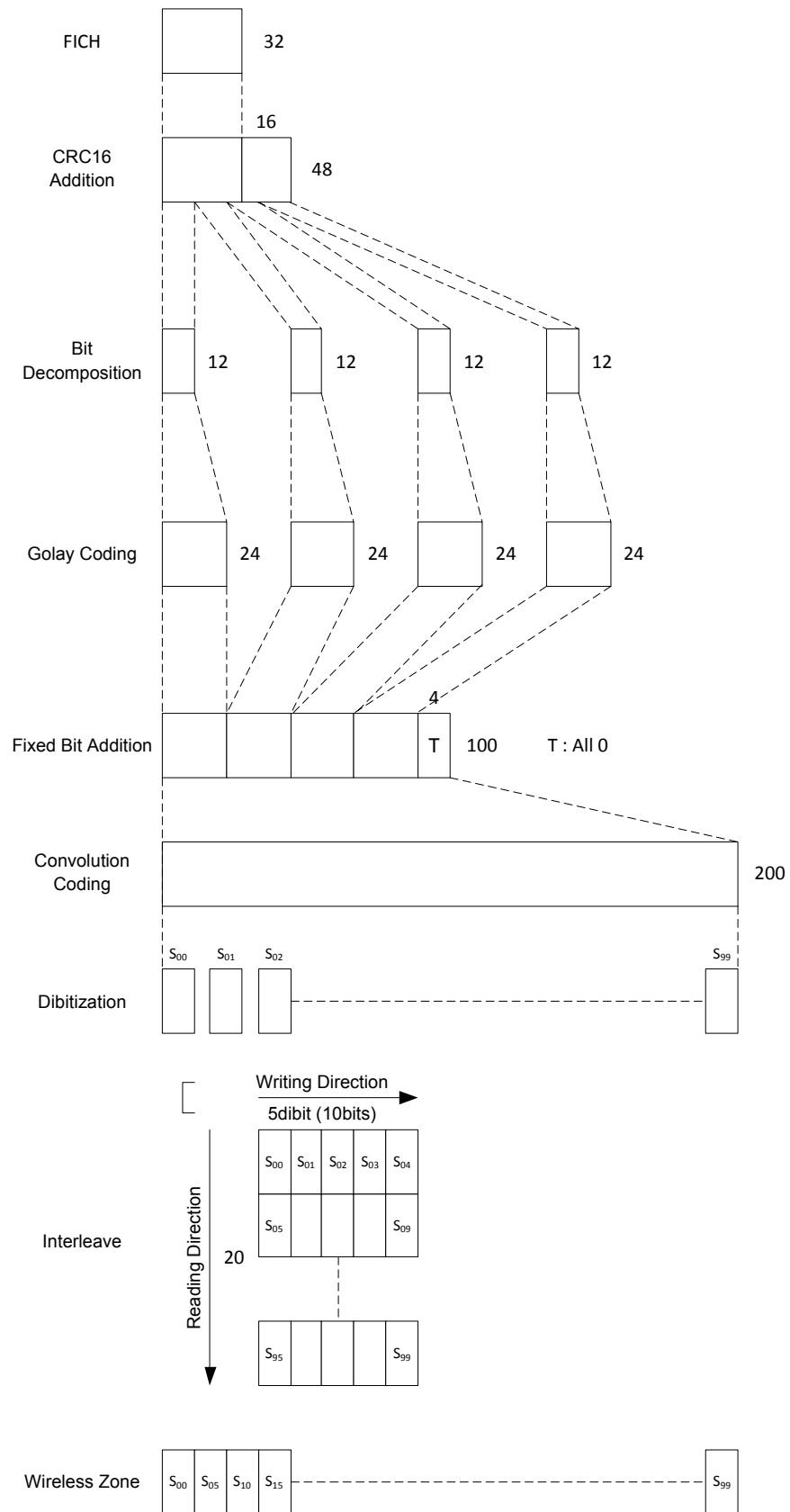

Figure 4-26 Frame Information Channel (FICH) Coding Method

(2) DCH Section

Data Communication Channel (DCH: Data Channel)

(a) Encoding Procedure

The encoding procedure for a single unit is shown in **Figure 4-27**.

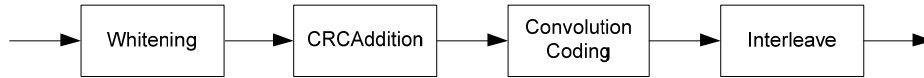

Figure 4-27 Single Unit Encoding Procedure

(b) Whitening

This is used for whitening of the data series. The whitening pattern assumes the PN (9,5) shown in **Figure 4-28** as output, and the respective XOR bits starting from the top bit of the unit as whitening output. The shift register shall be initialized for each unit.

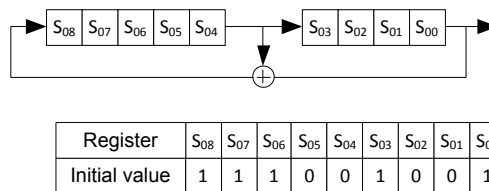

Figure 4-28 Configuration of PN (9,5) used in Unit Whitening

(c) Error Detection Code

16 bit CRC

Generator polynomial: $x^{16} + x^{12} + x^5 + 1$

The configuration of the CRC encoder must be as shown in **Figure 4-29**. The initial values of all the shift registers $S_{15} - S_{00}$ shall be zero and all bits must be inverted at the end.

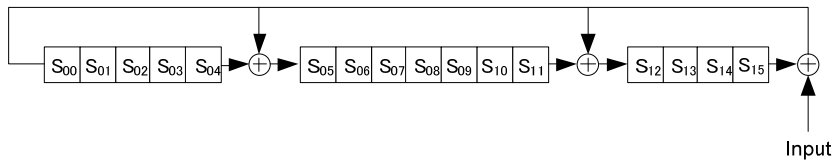

Figure 4-29 CRC16 Encoder Configuration

(c) Trellis Coding (refer to **Appendix B**)

The convoluted coding shown below must be carried out using a sequence with four fixed bits (All 0) added at the end of an input bit string as input. The output bit must be read alternately in the order of G_1 followed by G_2 .

Coding rate $R = 1/2$

Constraint length $K = 5$

Generator polynomial:
 $G_1 = x^4 + x^3 + 1$
 $G_2 = x^4 + x^2 + x + 1$

(e) Interleave

After reading the input bit in 2 bit segments and then after making a dibit, an interleave with block length $M = 9$ dibits and depth $N = 20$ must be carried out.

(f) Encoding Details

The encoding details of a single unit are shown in **Figure 4-30** and **Figure 4-31**.

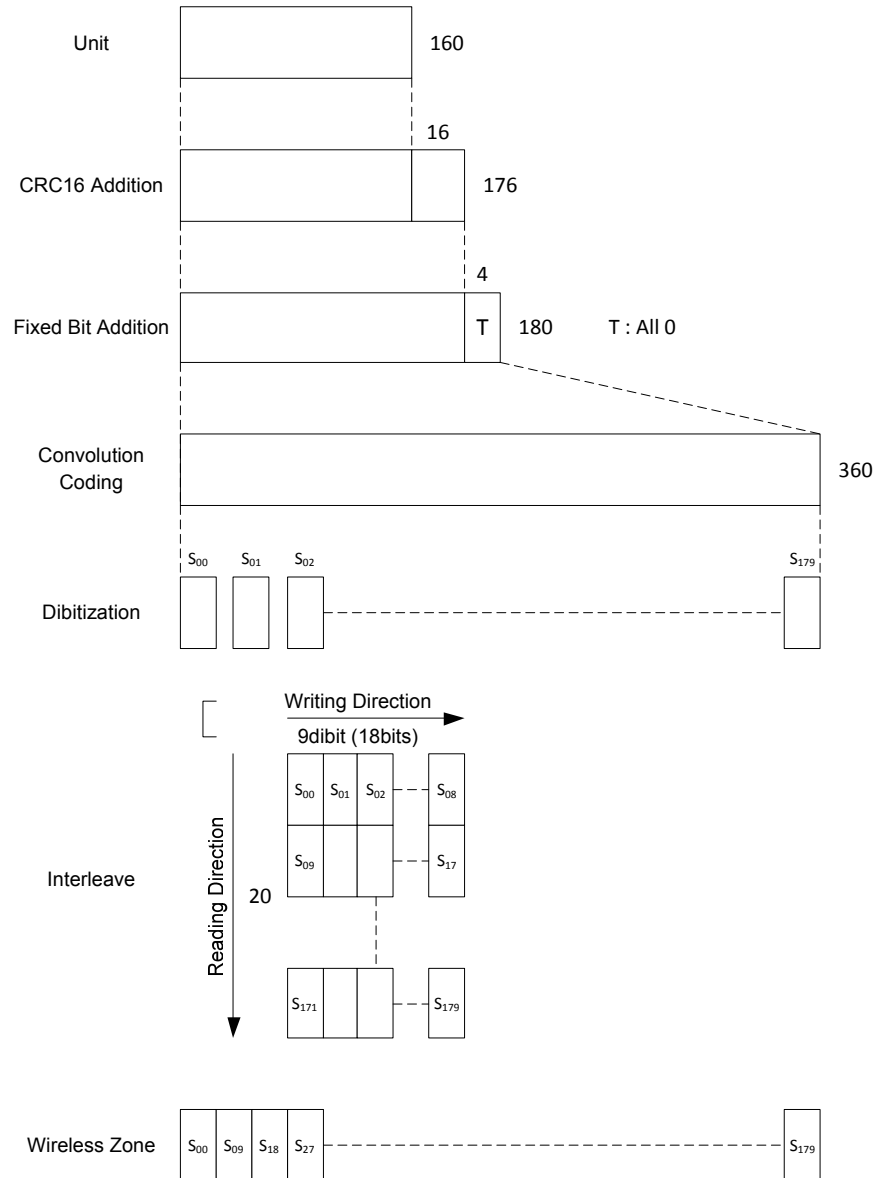

Figure 4-30 Data Communication Channel (DCH: HC (Header CH), TC (Terminator CH), V/D mode type 1CC and Data FR mode CC) Coding Method

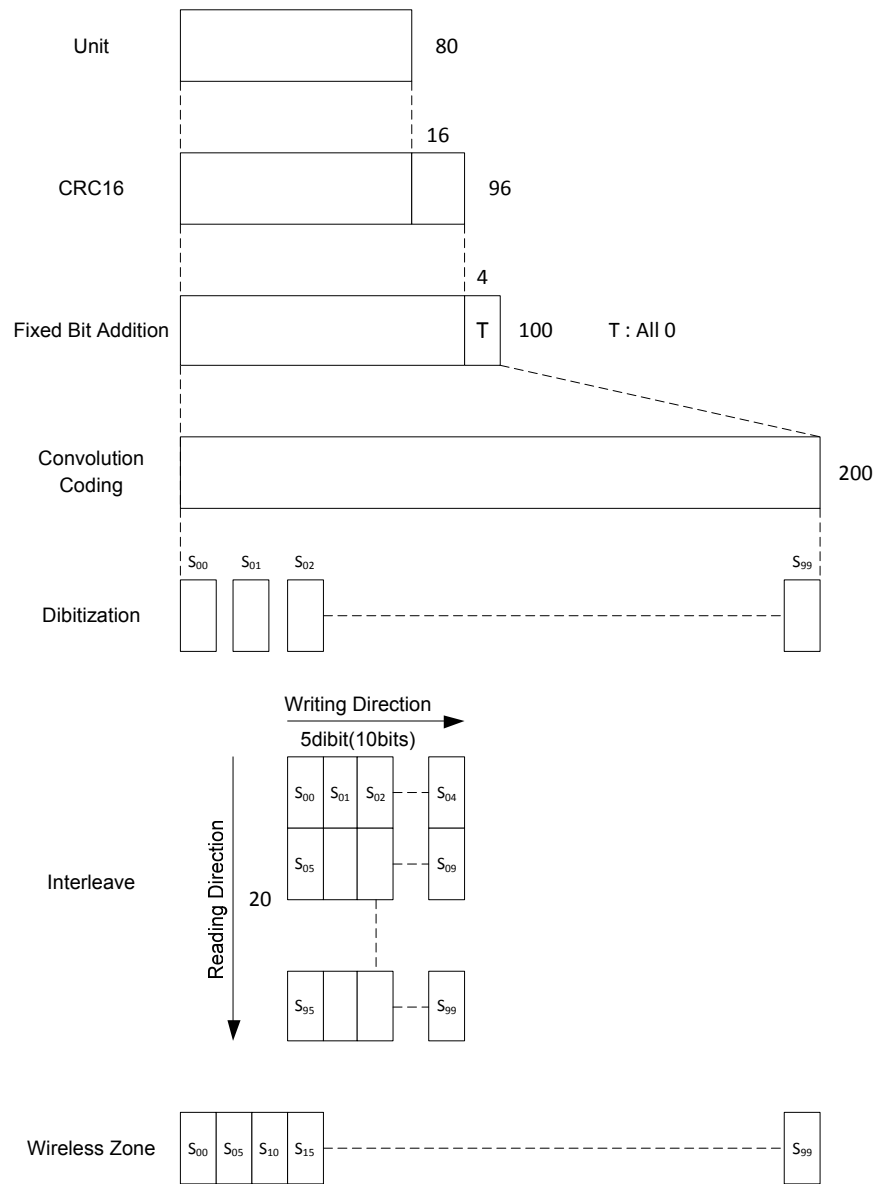

Figure 4-31 Data Communication Channel (DCH: V/D mode type 2 CC) Coding Method

(3) VCH Section and VeCH Section

In the case of V/D mode type 2, error correction for the purpose of improving the connectivity of a weak electric field is carried out (separately from the error correction function of the voice encoder). The 49 bit voice encoded data is split into 27 and 22 blocks in order to use the majority method as error correction. The 27 data bits in the first half are further divided into 3 bits each (81) which are then combined with the 22 bits in the divided second half (103). 1bit (0) is added (104). The same whitening as the DCH is applied, and then an interleave with block length $M = 26$ bit and depth $N = 4$ is carried out to divide it into VCH (72) and VeCH (32).

The encoding details of the V/D mode type 2 (simultaneous data communication mode 2) is shown in **Figure 4-32**.

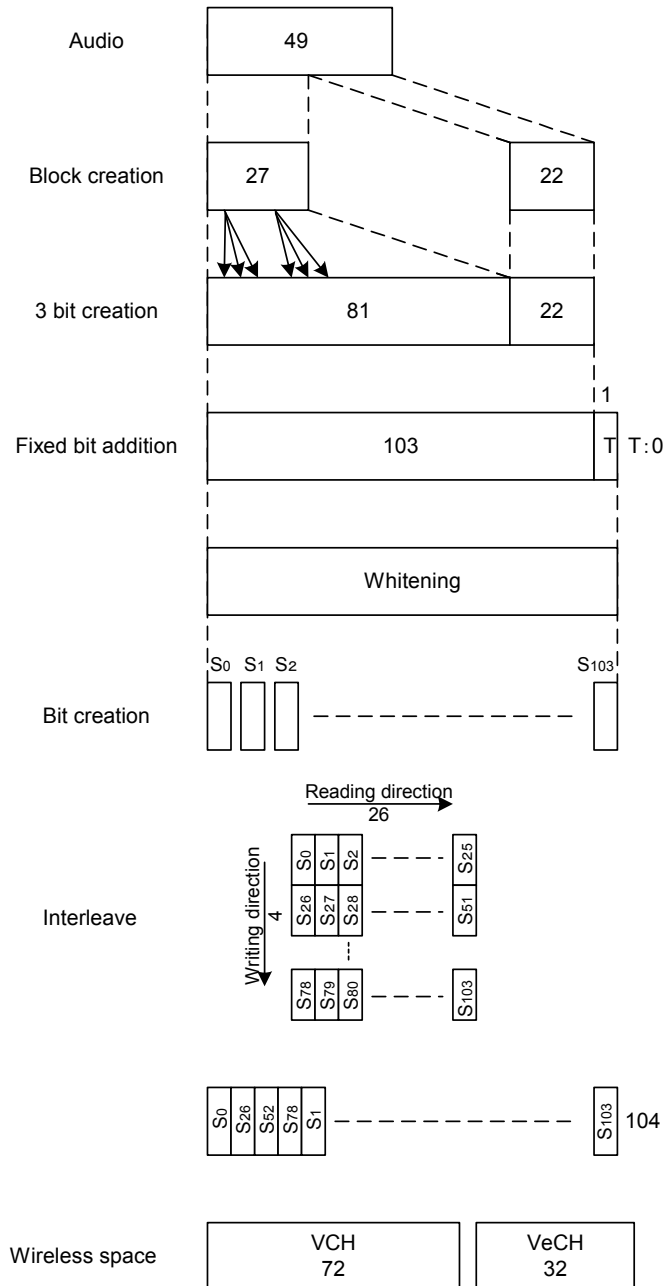

Figure 4-32 V/D mode type 2 VCH Section and VeCH Section Coding Method

4.6 Communication Channel Start-up / Keep / Stop Conditions

(1) Communication Channel Start-up Procedure

Before transmitting in the communication channel (CC), the radio must continuously transmit the head channel (HC) a prescribed number of times (N_0 : Recommended value is 1).

(2) Communication Channel Keep Condition

If the frame synchronization is out-of-sync during communication or when there is a failure in migrating from the head channel to the communication channel, autonomous synchronization capture must be carried out in the reception communication channel.

(3) Communication Channel Stop Condition

Not specified.

4.7 Frame Synchronization

(1) Synchronization Establishment Conditions

When frame synchronization symbols are received N_1 times continuously (recommended value 1).

(2) Out-of-Sync Conditions

When frame synchronization symbols cannot be received N_2 times continuously (recommended value 4).

Appendix

A. Extended Golay Code (24, 12, 8)

The txd coded data is obtained by applying the Golay (24, 12, 8) generation matrix on the original 12 bit data.

$$txd = [d_{11} \ d_{10} \ d_9 \ d_8 \ d_7 \ d_6 \ d_5 \ d_4 \ d_3 \ d_2 \ d_1 \ d_0] \cdot \begin{bmatrix} 1 & 0 & 0 & 0 & 0 & 0 & 0 & 0 & 0 & 0 & 0 & 0 & 1 & 1 & 0 & 0 & 0 & 1 & 1 & 1 & 0 & 1 & 0 & 1 \\ 0 & 1 & 0 & 0 & 0 & 0 & 0 & 0 & 0 & 0 & 0 & 0 & 0 & 1 & 1 & 0 & 0 & 0 & 1 & 1 & 1 & 0 & 1 & 1 \\ 0 & 0 & 1 & 0 & 0 & 0 & 0 & 0 & 0 & 0 & 0 & 0 & 1 & 1 & 1 & 1 & 0 & 1 & 1 & 0 & 1 & 0 & 0 & 0 \\ 0 & 0 & 0 & 1 & 0 & 0 & 0 & 0 & 0 & 0 & 0 & 0 & 0 & 1 & 1 & 1 & 1 & 0 & 1 & 1 & 0 & 1 & 0 & 0 \\ 0 & 0 & 0 & 0 & 1 & 0 & 0 & 0 & 0 & 0 & 0 & 0 & 0 & 1 & 1 & 1 & 1 & 0 & 1 & 1 & 0 & 1 & 0 & 1 \\ 0 & 0 & 0 & 0 & 0 & 1 & 0 & 0 & 0 & 0 & 0 & 0 & 1 & 1 & 0 & 1 & 1 & 0 & 0 & 1 & 1 & 0 & 0 & 1 \\ 0 & 0 & 0 & 0 & 0 & 0 & 1 & 0 & 0 & 0 & 0 & 0 & 0 & 1 & 1 & 0 & 1 & 1 & 0 & 0 & 1 & 1 & 0 & 1 \\ 0 & 0 & 0 & 0 & 0 & 0 & 0 & 1 & 0 & 0 & 0 & 0 & 0 & 1 & 1 & 0 & 1 & 1 & 0 & 0 & 1 & 1 & 1 & 1 \\ 0 & 0 & 0 & 0 & 0 & 0 & 0 & 0 & 1 & 0 & 0 & 0 & 1 & 1 & 0 & 1 & 1 & 1 & 0 & 0 & 0 & 1 & 1 & 0 \\ 0 & 0 & 0 & 0 & 0 & 0 & 0 & 0 & 0 & 1 & 0 & 0 & 1 & 0 & 1 & 0 & 1 & 0 & 0 & 1 & 0 & 1 & 1 & 1 \\ 0 & 0 & 0 & 0 & 0 & 0 & 0 & 0 & 0 & 0 & 1 & 0 & 1 & 0 & 0 & 1 & 0 & 0 & 1 & 1 & 1 & 1 & 1 & 0 \\ 0 & 0 & 0 & 0 & 0 & 0 & 0 & 0 & 0 & 0 & 0 & 1 & 1 & 0 & 0 & 0 & 1 & 1 & 1 & 0 & 1 & 0 & 1 & 1 \end{bmatrix}$$

Encoded data is

$$txd = [d_{11} \ d_{10} \ d_9 \ d_8 \ d_7 \ d_6 \ d_5 \ d_4 \ d_3 \ d_2 \ d_1 \ d_0 \ p_{11} \ p_{10} \ p_9 \ p_8 \ p_7 \ p_6 \ p_5 \ p_4 \ p_3 \ p_2 \ p_1 \ p_0]$$

B. Trellis encoder Coding rate $R = 1/2$ Constraint length $K = 5$

The configuration of the Trellis encoder is shown in **Figure B-1**.

$$G1 = x^4 + x^3 + 1$$

$$G2 = x^4 + x^2 + x + 1$$

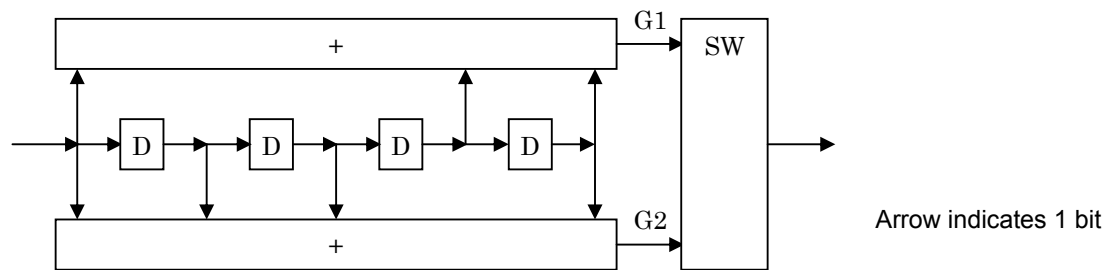

Figure B-1 Trellis Encoder

In the figure above, the initial encoder registers D are all set to 0 and data is then entered while shifting through them.

The output switches between G1 and G2 for every shift.

YAESU
The radio

YAESU MUSEN CO., LTD.

Tennozu Parkside Building,
2-5-8, Higashi Shinagawa, Shinagawa-ku, Tokyo 140-0002, JAPAN
